

UTS SALES AND REPAIRS

A SAFER WAY TO REACH NEW HEIGHTS

Single Width Tower
2.5m Long x 0.85m Wide

Working Height
3.2m

Platform Height
1.2m

Tower Components

Item	Description	Quantity
1	Locking Caster	4
2	Adjustable Leg	4
3	2 Rung Ladder Frame	0
4	2 Rung Span Frame	0
5	3 Rung Ladder Frame	0
6	3 Rung Span Frame	0
7	4 Rung Ladder Frame	1
8	4 Rung Span Frame	1
9	2.5m Trapdoor Platform	1
10	2.5m Fixed Platform	0
11	2.5m Horizontal Brace	6
12	2.7m Diagonal Brace	2
13	Small Stabiliser	0
14	Large Stabiliser	0
15	Folding Toeboard	1

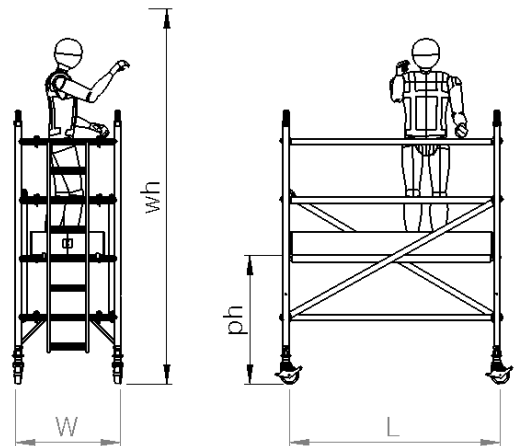

Technical information:

Base Dimensions:	(L)2.5m X (W)0.85m
Maximum Platform Height (ph):	1.2m
Maximum Working Height (wh):	3.2m
Maximum Working Load Per Platform:	275kg
Maximum Working Load Per Tower: (including tower weight)	950kg
Weight:	97.9kg

Example picture of a 1450 1.8m 2.2m Platform Height GRP Tower

01227 860085
Mon-Fri, 8am until 5pm

For More Information:
info@towersandpodiums.co.uk
We reply within 1 hour
Mon-Fri, 8am until 5pm



UTS SALES AND REPAIRS

A SAFER WAY TO REACH NEW HEIGHTS

Single Width Tower
2.5m Long x 0.85m Wide

Working Height
3.7m

Platform Height
1.7m

Tower Components

Item	Description	Quantity
1	Locking Caster	4
2	Adjustable Leg	4
3	2 Rung Ladder Frame	1
4	2 Rung Span Frame	1
5	3 Rung Ladder Frame	1
6	3 Rung Span Frame	1
7	4 Rung Ladder Frame	0
8	4 Rung Span Frame	0
9	2.5m Trapdoor Platform	1
10	2.5m Fixed Platform	0
11	2.5m Horizontal Brace	6
12	2.7m Diagonal Brace	3
13	Small Stabiliser	0
14	Large Stabiliser	0
15	Folding Toeboard	1

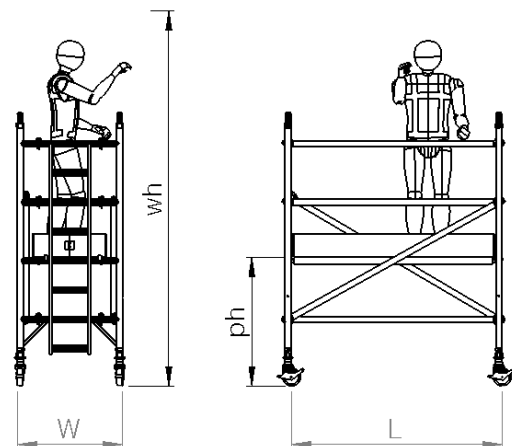

Technical information:

Base Dimensions:	(L)2.5m X (W)0.85m
Maximum Platform Height (ph):	1.7m
Maximum Working Height (wh):	3.7m
Maximum Working Load Per Platform:	275kg
Maximum Working Load Per Tower: (including tower weight)	950kg
Weight:	106.7kg

Example picture of a 1450 1.8m 2.2m Platform Height GRP Tower

01227 860085
Mon-Fri, 8am until 5pm

For More Information:
info@towersandpodiums.co.uk
We reply within 1 hour
Mon-Fri, 8am until 5pm



UTS SALES AND REPAIRS

A SAFER WAY TO REACH NEW HEIGHTS

Single Width Tower
2.5m Long x 0.85m Wide

Working Height
4.2m

Platform Height
2.2m

Tower Components

Item	Description	Quantity
1	Locking Caster	4
2	Adjustable Leg	4
3	2 Rung Ladder Frame	1
4	2 Rung Span Frame	1
5	3 Rung Ladder Frame	0
6	3 Rung Span Frame	0
7	4 Rung Ladder Frame	1
8	4 Rung Span Frame	1
9	2.5m Trapdoor Platform	1
10	2.5m Fixed Platform	0
11	2.5m Horizontal Brace	6
12	2.7m Diagonal Brace	3
13	Small Stabiliser	0
14	Large Stabiliser	0
15	Folding Toeboard	1

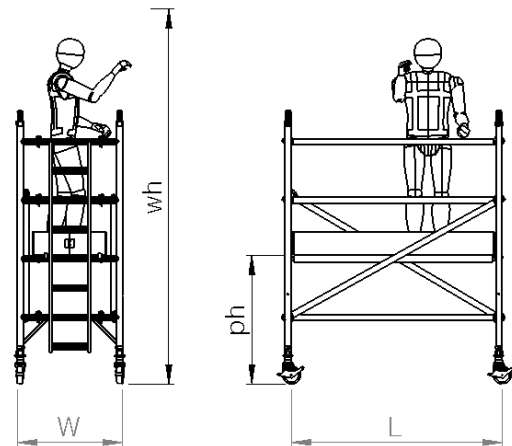

Technical information:

Base Dimensions:	(L)2.5m X (W)0.85m
Maximum Platform Height (ph):	2.2m
Maximum Working Height (wh):	4.2m
Maximum Working Load Per Platform:	275kg
Maximum Working Load Per Tower: (including tower weight)	950kg
Weight:	112.1kg

Example picture of a 1450 1.8m 2.2m Platform Height GRP Tower

01227 860085
Mon-Fri, 8am until 5pm

For More Information:
info@towersandpodiums.co.uk
We reply within 1 hour
Mon-Fri, 8am until 5pm



UTS SALES AND REPAIRS

A SAFER WAY TO REACH NEW HEIGHTS

Single Width Tower
2.5m Long x 0.85m Wide

Working Height
4.7m

Platform Height
2.7m

Tower Components

Item	Description	Quantity
1	Locking Caster	4
2	Adjustable Leg	4
3	2 Rung Ladder Frame	0
4	2 Rung Span Frame	0
5	3 Rung Ladder Frame	1
6	3 Rung Span Frame	1
7	4 Rung Ladder Frame	1
8	4 Rung Span Frame	1
9	2.5m Trapdoor Platform	2
10	2.5m Fixed Platform	0
11	2.5m Horizontal Brace	6
12	2.7m Diagonal Brace	4
13	Small Stabiliser	4
14	Large Stabiliser	0
15	Folding Toeboard	1

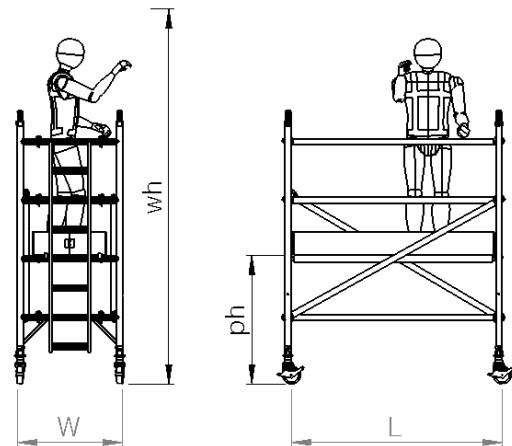

Technical information:

Base Dimensions:	(L)2.5m X (W)0.85m
Maximum Platform Height (ph):	2.7m
Maximum Working Height (wh):	4.7m
Maximum Working Load Per Platform:	275kg
Maximum Working Load Per Tower: (including tower weight)	950kg
Weight:	162.8kg

Example picture of a 1450 1.8m 2.2m Platform Height GRP Tower

01227 860085
Mon-Fri, 8am until 5pm

For More Information:
info@towersandpodiums.co.uk
We reply within 1 hour
Mon-Fri, 8am until 5pm



UTS SALES AND REPAIRS

A SAFER WAY TO REACH NEW HEIGHTS

Single Width Tower
2.5m Long x 0.85m Wide

Working Height
5.2m

Platform Height
3.2m

Tower Components

Item	Description	Quantity
1	Locking Caster	4
2	Adjustable Leg	4
3	2 Rung Ladder Frame	0
4	2 Rung Span Frame	0
5	3 Rung Ladder Frame	0
6	3 Rung Span Frame	0
7	4 Rung Ladder Frame	2
8	4 Rung Span Frame	2
9	2.5m Trapdoor Platform	2
10	2.5m Fixed Platform	0
11	2.5m Horizontal Brace	10
12	2.7m Diagonal Brace	5
13	Small Stabiliser	4
14	Large Stabiliser	0
15	Folding Toeboard	1

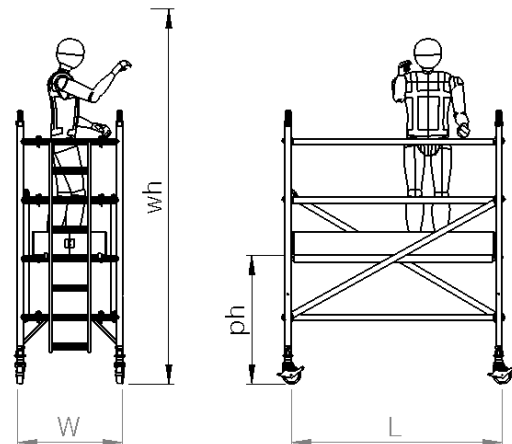

Technical information:

Base Dimensions:	(L)2.5m X (W)0.85m
Maximum Platform Height (ph):	3.2m
Maximum Working Height (wh):	5.2m
Maximum Working Load Per Platform:	275kg
Maximum Working Load Per Tower: (including tower weight)	950kg
Weight:	182.0kg

Example picture of a 1450 1.8m 2.2m Platform Height GRP Tower

01227 860085
Mon-Fri, 8am until 5pm

For More Information:
info@towersandpodiums.co.uk
We reply within 1 hour
Mon-Fri, 8am until 5pm



UTS SALES AND REPAIRS

A SAFER WAY TO REACH NEW HEIGHTS

Single Width Tower
2.5m Long x 0.85m Wide

Working Height
5.7m

Platform Height
3.7m

Tower Components

Item	Description	Quantity
1	Locking Caster	4
2	Adjustable Leg	4
3	2 Rung Ladder Frame	1
4	2 Rung Span Frame	1
5	3 Rung Ladder Frame	1
6	3 Rung Span Frame	1
7	4 Rung Ladder Frame	1
8	4 Rung Span Frame	1
9	2.5m Trapdoor Platform	2
10	2.5m Fixed Platform	0
11	2.5m Horizontal Brace	10
12	2.7m Diagonal Brace	6
13	Small Stabiliser	4
14	Large Stabiliser	0
15	Folding Toeboard	1

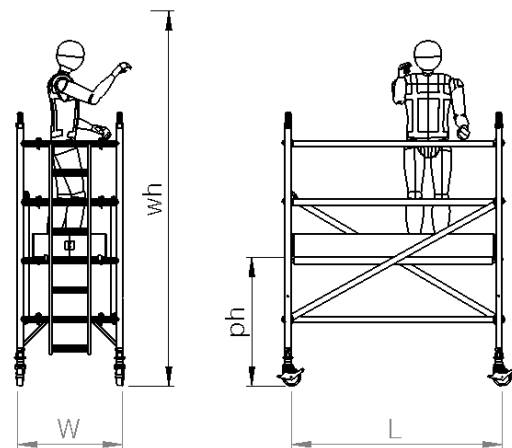

Technical information:

Base Dimensions:	(L)2.5m X (W)0.85m
Maximum Platform Height (ph):	3.7m
Maximum Working Height (wh):	5.7m
Maximum Working Load Per Platform:	275kg
Maximum Working Load Per Tower: (including tower weight)	950kg
Weight:	190.7kg

Example picture of a 1450 1.8m 2.2m Platform Height GRP Tower

01227 860085
Mon-Fri, 8am until 5pm

For More Information:
info@towersandpodiums.co.uk
We reply within 1 hour
Mon-Fri, 8am until 5pm



UTS SALES AND REPAIRS

A SAFER WAY TO REACH NEW HEIGHTS

Single Width Tower
2.5m Long x 0.85m Wide

Working Height
6.2m

Platform Height
4.2m

Tower Components

Item	Description	Quantity
1	Locking Caster	4
2	Adjustable Leg	4
3	2 Rung Ladder Frame	1
4	2 Rung Span Frame	1
5	3 Rung Ladder Frame	0
6	3 Rung Span Frame	0
7	4 Rung Ladder Frame	2
8	4 Rung Span Frame	2
9	2.5m Trapdoor Platform	2
10	2.5m Fixed Platform	0
11	2.5m Horizontal Brace	10
12	2.7m Diagonal Brace	7
13	Small Stabiliser	4
14	Large Stabiliser	0
15	Folding Toeboard	1

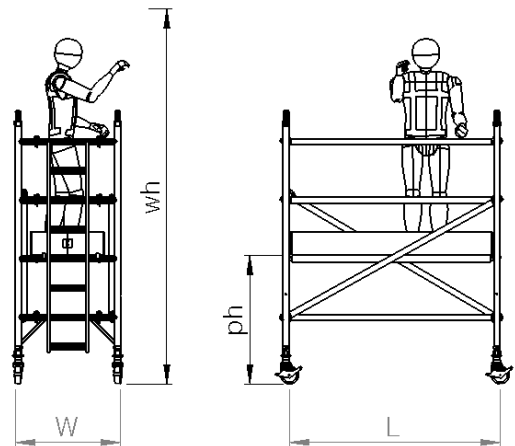

Technical information:

Base Dimensions:	(L)2.5m X (W)0.85m
Maximum Platform Height (ph):	4.2m
Maximum Working Height (wh):	6.2m
Maximum Working Load Per Platform:	275kg
Maximum Working Load Per Tower: (including tower weight)	950kg
Weight:	199.0kg

Example picture of a 1450 1.8m 2.2m Platform Height GRP Tower

01227 860085
Mon-Fri, 8am until 5pm

For More Information:
info@towersandpodiums.co.uk
We reply within 1 hour
Mon-Fri, 8am until 5pm



UTS SALES AND REPAIRS

A SAFER WAY TO REACH NEW HEIGHTS

Single Width Tower
2.5m Long x 0.85m Wide

Working Height
6.7m

Platform Height
4.7m

Tower Components

Item	Description	Quantity
1	Locking Caster	4
2	Adjustable Leg	4
3	2 Rung Ladder Frame	0
4	2 Rung Span Frame	0
5	3 Rung Ladder Frame	1
6	3 Rung Span Frame	1
7	4 Rung Ladder Frame	2
8	4 Rung Span Frame	2
9	2.5m Trapdoor Platform	2
10	2.5m Fixed Platform	0
11	2.5m Horizontal Brace	10
12	2.7m Diagonal Brace	8
13	Small Stabiliser	0
14	Large Stabiliser	4
15	Folding Toeboard	1

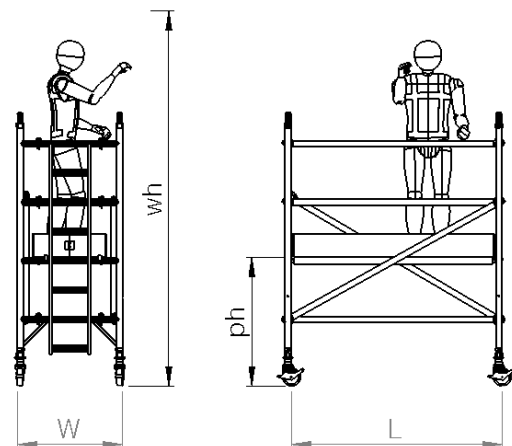

Technical information:

Base Dimensions:	(L)2.5m X (W)0.85m
Maximum Platform Height (ph):	4.7m
Maximum Working Height (wh):	6.7m
Maximum Working Load Per Platform:	275kg
Maximum Working Load Per Tower: (including tower weight)	950kg
Weight:	209.1kg

Example picture of a 1450 1.8m 2.2m Platform Height GRP Tower

01227 860085
Mon-Fri, 8am until 5pm

For More Information:
info@towersandpodiums.co.uk
We reply within 1 hour
Mon-Fri, 8am until 5pm



UTS SALES AND REPAIRS

A SAFER WAY TO REACH NEW HEIGHTS

Single Width Tower
2.5m Long x 0.85m Wide

Working Height
7.2m

Platform Height
5.2m

Tower Components

Item	Description	Quantity
1	Locking Caster	4
2	Adjustable Leg	4
3	2 Rung Ladder Frame	0
4	2 Rung Span Frame	0
5	3 Rung Ladder Frame	0
6	3 Rung Span Frame	0
7	4 Rung Ladder Frame	3
8	4 Rung Span Frame	3
9	2.5m Trapdoor Platform	3
10	2.5m Fixed Platform	0
11	2.5m Horizontal Brace	14
12	2.7m Diagonal Brace	9
13	Small Stabiliser	0
14	Large Stabiliser	4
15	Folding Toeboard	1

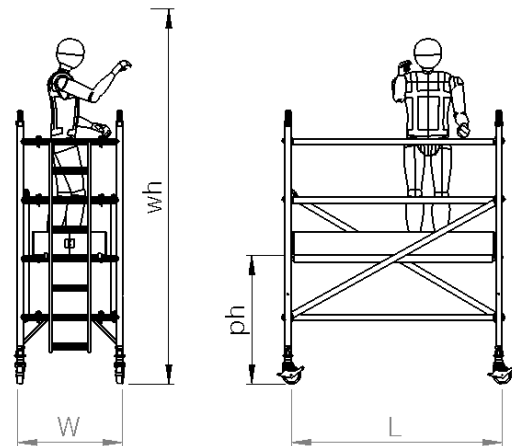

Technical information:

Base Dimensions:	(L)2.5m X (W)0.85m
Maximum Platform Height (ph):	5.2m
Maximum Working Height (wh):	7.2m
Maximum Working Load Per Platform:	275kg
Maximum Working Load Per Tower: (including tower weight)	950kg
Weight:	253.3kg

Example picture of a 1450 1.8m 2.2m Platform Height GRP Tower

01227 860085
Mon-Fri, 8am until 5pm

For More Information:
info@towersandpodiums.co.uk
We reply within 1 hour
Mon-Fri, 8am until 5pm



UTS SALES AND REPAIRS

A SAFER WAY TO REACH NEW HEIGHTS

Single Width Tower
2.5m Long x 0.85m Wide

Working Height
7.7m

Platform Height
5.7m

Tower Components

Item	Description	Quantity
1	Locking Caster	4
2	Adjustable Leg	4
3	2 Rung Ladder Frame	1
4	2 Rung Span Frame	1
5	3 Rung Ladder Frame	1
6	3 Rung Span Frame	1
7	4 Rung Ladder Frame	2
8	4 Rung Span Frame	2
9	2.5m Trapdoor Platform	3
10	2.5m Fixed Platform	0
11	2.5m Horizontal Brace	14
12	2.7m Diagonal Brace	10
13	Small Stabiliser	0
14	Large Stabiliser	4
15	Folding Toeboard	1

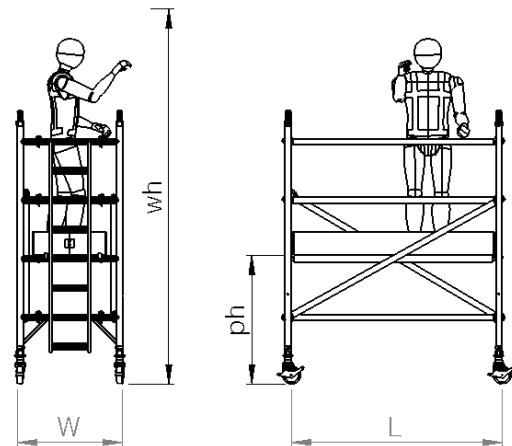

Technical information:

Base Dimensions:	(L)2.5m X (W)0.85m
Maximum Platform Height (ph):	5.7m
Maximum Working Height (wh):	7.7m
Maximum Working Load Per Platform:	275kg
Maximum Working Load Per Tower: (including tower weight)	950kg
Weight:	262.1kg

Example picture of a 1450 1.8m 2.2m Platform Height GRP Tower

01227 860085
Mon-Fri, 8am until 5pm

For More Information:
info@towersandpodiums.co.uk
We reply within 1 hour
Mon-Fri, 8am until 5pm



UTS SALES AND REPAIRS

A SAFER WAY TO REACH NEW HEIGHTS

Single Width Tower
2.5m Long x 0.85m Wide

Working Height
8.2m

Platform Height
6.2m

Tower Components

Item	Description	Quantity
1	Locking Caster	4
2	Adjustable Leg	4
3	2 Rung Ladder Frame	1
4	2 Rung Span Frame	1
5	3 Rung Ladder Frame	0
6	3 Rung Span Frame	0
7	4 Rung Ladder Frame	3
8	4 Rung Span Frame	3
9	2.5m Trapdoor Platform	3
10	2.5m Fixed Platform	0
11	2.5m Horizontal Brace	14
12	2.7m Diagonal Brace	11
13	Small Stabiliser	0
14	Large Stabiliser	4
15	Folding Toeboard	1

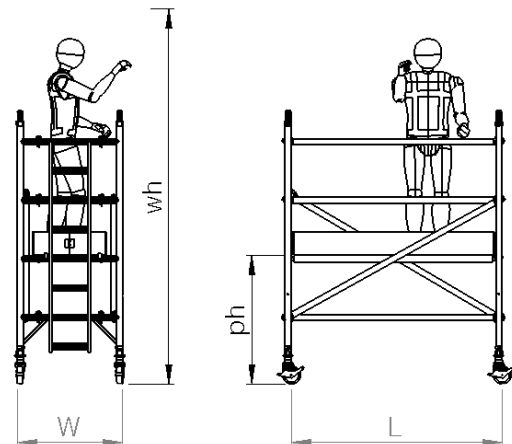

Technical information:

Base Dimensions:	(L)2.5m X (W)0.85m
Maximum Platform Height (ph):	6.2m
Maximum Working Height (wh):	8.2m
Maximum Working Load Per Platform:	275kg
Maximum Working Load Per Tower: (including tower weight)	950kg
Weight:	270.3kg

Example picture of a 1450 1.8m 2.2m Platform Height GRP Tower

01227 860085
Mon-Fri, 8am until 5pm

For More Information:
info@towersandpodiums.co.uk
We reply within 1 hour
Mon-Fri, 8am until 5pm



UTS SALES AND REPAIRS

A SAFER WAY TO REACH NEW HEIGHTS

Single Width Tower
2.5m Long x 0.85m Wide

Working Height
8.7m

Platform Height
6.7m

Tower Components

Item	Description	Quantity
1	Locking Caster	4
2	Adjustable Leg	4
3	2 Rung Ladder Frame	0
4	2 Rung Span Frame	0
5	3 Rung Ladder Frame	1
6	3 Rung Span Frame	1
7	4 Rung Ladder Frame	3
8	4 Rung Span Frame	3
9	2.5m Trapdoor Platform	3
10	2.5m Fixed Platform	0
11	2.5m Horizontal Brace	14
12	2.7m Diagonal Brace	12
13	Small Stabiliser	0
14	Large Stabiliser	4
15	Folding Toeboard	1

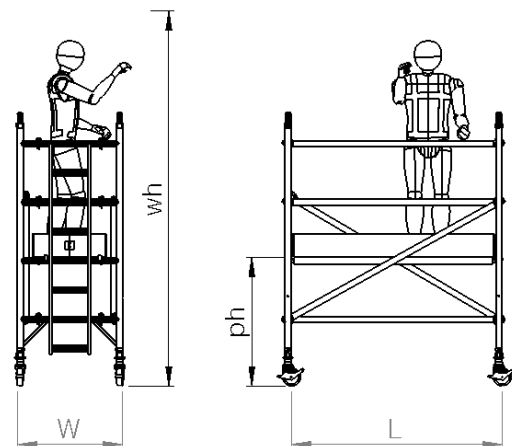

Technical information:

Base Dimensions:	(L)2.5m X (W)0.85m
Maximum Platform Height (ph):	6.7m
Maximum Working Height (wh):	8.7m
Maximum Working Load Per Platform:	275kg
Maximum Working Load Per Tower: (including tower weight)	950kg
Weight:	277.2kg

Example picture of a 1450 1.8m 2.2m Platform Height GRP Tower

01227 860085
Mon-Fri, 8am until 5pm

For More Information:
info@towersandpodiums.co.uk
We reply within 1 hour
Mon-Fri, 8am until 5pm



UTS SALES AND REPAIRS

A SAFER WAY TO REACH NEW HEIGHTS

Single Width Tower
2.5m Long x 0.85m Wide

Working Height
9.2m

Platform Height
7.2m

Tower Components

Item	Description	Quantity
1	Locking Caster	4
2	Adjustable Leg	4
3	2 Rung Ladder Frame	0
4	2 Rung Span Frame	0
5	3 Rung Ladder Frame	0
6	3 Rung Span Frame	0
7	4 Rung Ladder Frame	4
8	4 Rung Span Frame	4
9	2.5m Trapdoor Platform	4
10	2.5m Fixed Platform	0
11	2.5m Horizontal Brace	18
12	2.7m Diagonal Brace	13
13	Small Stabiliser	0
14	Large Stabiliser	4
15	Folding Toeboard	1

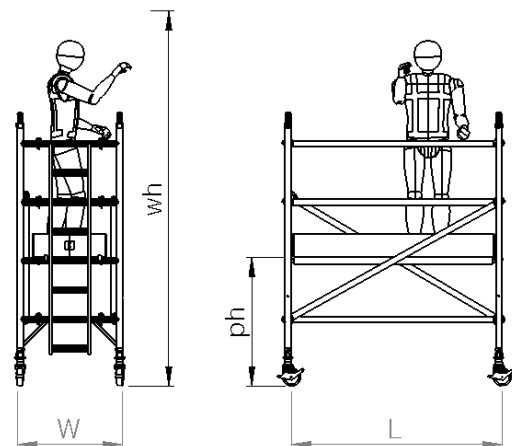

Technical information:

Base Dimensions:	(L)2.5m X (W)0.85m
Maximum Platform Height (ph):	7.2m
Maximum Working Height (wh):	9.2m
Maximum Working Load Per Platform:	275kg
Maximum Working Load Per Tower: (including tower weight)	950kg
Weight:	321.4kg

Example picture of a 1450 1.8m 2.2m Platform Height GRP Tower

01227 860085
Mon-Fri, 8am until 5pm

For More Information:
info@towersandpodiums.co.uk
We reply within 1 hour
Mon-Fri, 8am until 5pm



UTS SALES AND REPAIRS

A SAFER WAY TO REACH NEW HEIGHTS

Single Width Tower
2.5m Long x 0.85m Wide

Working Height
9.7m

Platform Height
7.7m

Tower Components

Item	Description	Quantity
1	Locking Caster	4
2	Adjustable Leg	4
3	2 Rung Ladder Frame	1
4	2 Rung Span Frame	1
5	3 Rung Ladder Frame	1
6	3 Rung Span Frame	1
7	4 Rung Ladder Frame	3
8	4 Rung Span Frame	3
9	2.5m Trapdoor Platform	4
10	2.5m Fixed Platform	0
11	2.5m Horizontal Brace	18
12	2.7m Diagonal Brace	14
13	Small Stabiliser	0
14	Large Stabiliser	4
15	Folding Toeboard	1

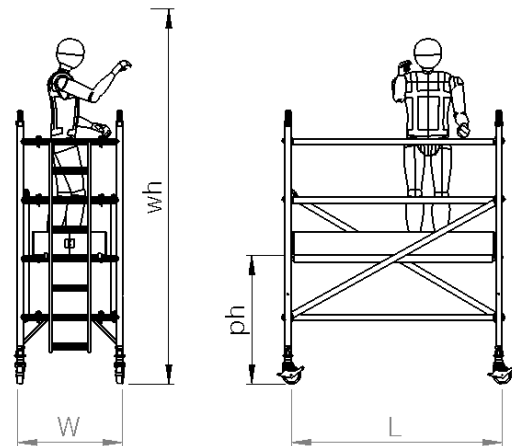

Technical information:

Base Dimensions:	(L)2.5m X (W)0.85m
Maximum Platform Height (ph):	7.7m
Maximum Working Height (wh):	9.7m
Maximum Working Load Per Platform:	275kg
Maximum Working Load Per Tower: (including tower weight)	950kg
Weight:	330.2kg

Example picture of a 1450 1.8m 2.2m Platform Height GRP Tower

01227 860085
Mon-Fri, 8am until 5pm

For More Information:
info@towersandpodiums.co.uk
We reply within 1 hour
Mon-Fri, 8am until 5pm



UTS SALES AND REPAIRS

A SAFER WAY TO REACH NEW HEIGHTS

Single Width Tower
2.5m Long x 0.85m Wide

Working Height
10.2m

Platform Height
8.2m

Tower Components

Item	Description	Quantity
1	Locking Caster	4
2	Adjustable Leg	4
3	2 Rung Ladder Frame	1
4	2 Rung Span Frame	1
5	3 Rung Ladder Frame	0
6	3 Rung Span Frame	0
7	4 Rung Ladder Frame	4
8	4 Rung Span Frame	4
9	2.5m Trapdoor Platform	4
10	2.5m Fixed Platform	0
11	2.5m Horizontal Brace	18
12	2.7m Diagonal Brace	15
13	Small Stabiliser	0
14	Large Stabiliser	4
15	Folding Toeboard	1

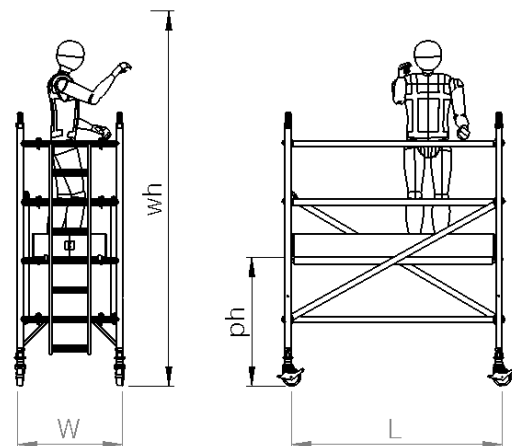

Technical information:

Base Dimensions:	(L)2.5m X (W)0.85m
Maximum Platform Height (ph):	8.2m
Maximum Working Height (wh):	10.2m
Maximum Working Load Per Platform:	275kg
Maximum Working Load Per Tower: (including tower weight)	950kg
Weight:	338.4kg

Example picture of a 1450 1.8m 2.2m Platform Height GRP Tower

01227 860085
Mon-Fri, 8am until 5pm

For More Information:
info@towersandpodiums.co.uk
We reply within 1 hour
Mon-Fri, 8am until 5pm



UTS SALES AND REPAIRS

A SAFER WAY TO REACH NEW HEIGHTS

Single Width Tower
2.5m Long x 0.85m Wide

Working Height
10.7m

Platform Height
8.7m

Tower Components

Item	Description	Quantity
1	Locking Caster	4
2	Adjustable Leg	4
3	2 Rung Ladder Frame	0
4	2 Rung Span Frame	0
5	3 Rung Ladder Frame	1
6	3 Rung Span Frame	1
7	4 Rung Ladder Frame	4
8	4 Rung Span Frame	4
9	2.5m Trapdoor Platform	4
10	2.5m Fixed Platform	0
11	2.5m Horizontal Brace	18
12	2.7m Diagonal Brace	16
13	Small Stabiliser	0
14	Large Stabiliser	4
15	Folding Toeboard	1

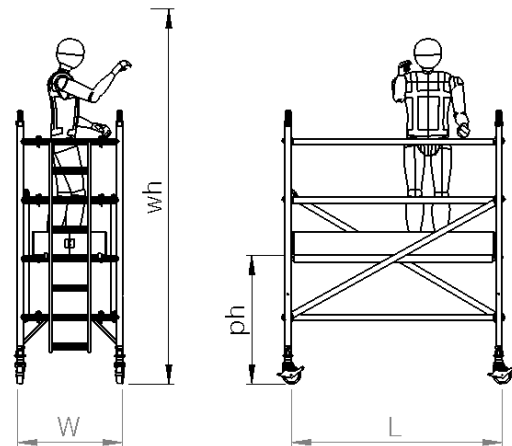

Technical information:

Base Dimensions:	(L)2.5m X (W)0.85m
Maximum Platform Height (ph):	8.7m
Maximum Working Height (wh):	10.7m
Maximum Working Load Per Platform:	275kg
Maximum Working Load Per Tower: (including tower weight)	950kg
Weight:	345.4kg

Example picture of a 1450 1.8m 2.2m Platform Height GRP Tower

01227 860085
Mon-Fri, 8am until 5pm

For More Information:
info@towersandpodiums.co.uk
We reply within 1 hour
Mon-Fri, 8am until 5pm



UTS SALES AND REPAIRS

A SAFER WAY TO REACH NEW HEIGHTS

Single Width Tower
2.5m Long x 0.85m Wide

Working Height
11.2m

Platform Height
9.2m

Tower Components

Item	Description	Quantity
1	Locking Caster	4
2	Adjustable Leg	4
3	2 Rung Ladder Frame	0
4	2 Rung Span Frame	0
5	3 Rung Ladder Frame	0
6	3 Rung Span Frame	0
7	4 Rung Ladder Frame	5
8	4 Rung Span Frame	5
9	2.5m Trapdoor Platform	5
10	2.5m Fixed Platform	0
11	2.5m Horizontal Brace	22
12	2.7m Diagonal Brace	17
13	Small Stabiliser	0
14	Large Stabiliser	4
15	Folding Toeboard	1

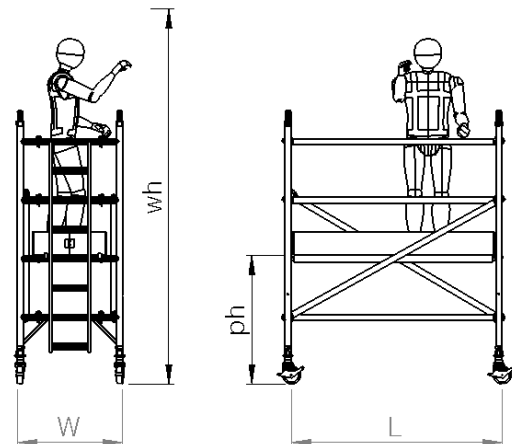

Technical information:

Base Dimensions:	(L)2.5m X (W)0.85m
Maximum Platform Height (ph):	9.2m
Maximum Working Height (wh):	11.2m
Maximum Working Load Per Platform:	275kg
Maximum Working Load Per Tower: (including tower weight)	950kg
Weight:	389.6kg

Example picture of a 1450 1.8m 2.2m Platform Height GRP Tower

01227 860085
Mon-Fri, 8am until 5pm

For More Information:
info@towersandpodiums.co.uk
We reply within 1 hour
Mon-Fri, 8am until 5pm



UTS SALES AND REPAIRS

A SAFER WAY TO REACH NEW HEIGHTS

Single Width Tower
2.5m Long x 0.85m Wide

Working Height
11.7m

Platform Height
9.7m

Tower Components

Item	Description	Quantity
1	Locking Caster	4
2	Adjustable Leg	4
3	2 Rung Ladder Frame	1
4	2 Rung Span Frame	1
5	3 Rung Ladder Frame	1
6	3 Rung Span Frame	1
7	4 Rung Ladder Frame	4
8	4 Rung Span Frame	4
9	2.5m Trapdoor Platform	5
10	2.5m Fixed Platform	0
11	2.5m Horizontal Brace	22
12	2.7m Diagonal Brace	18
13	Small Stabiliser	0
14	Large Stabiliser	4
15	Folding Toeboard	1

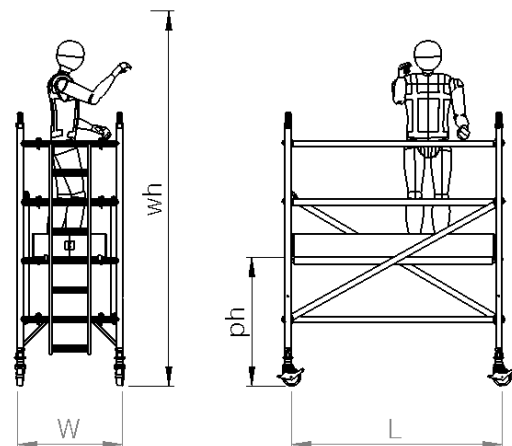

Technical information:

Base Dimensions:	(L)2.5m X (W)0.85m
Maximum Platform Height (ph):	9.7m
Maximum Working Height (wh):	11.7m
Maximum Working Load Per Platform:	275kg
Maximum Working Load Per Tower: (including tower weight)	950kg
Weight:	398.3kg

Example picture of a 1450 1.8m 2.2m Platform Height GRP Tower

01227 860085
Mon-Fri, 8am until 5pm

For More Information:
info@towersandpodiums.co.uk
We reply within 1 hour
Mon-Fri, 8am until 5pm



UTS SALES AND REPAIRS

A SAFER WAY TO REACH NEW HEIGHTS

Single Width Tower
2.5m Long x 0.85m Wide

Working Height
12.2m

Platform Height
10.2m

Tower Components

Item	Description	Quantity
1	Locking Caster	4
2	Adjustable Leg	4
3	2 Rung Ladder Frame	1
4	2 Rung Span Frame	1
5	3 Rung Ladder Frame	0
6	3 Rung Span Frame	0
7	4 Rung Ladder Frame	5
8	4 Rung Span Frame	5
9	2.5m Trapdoor Platform	5
10	2.5m Fixed Platform	0
11	2.5m Horizontal Brace	22
12	2.7m Diagonal Brace	19
13	Small Stabiliser	0
14	Large Stabiliser	4
15	Folding Toeboard	1

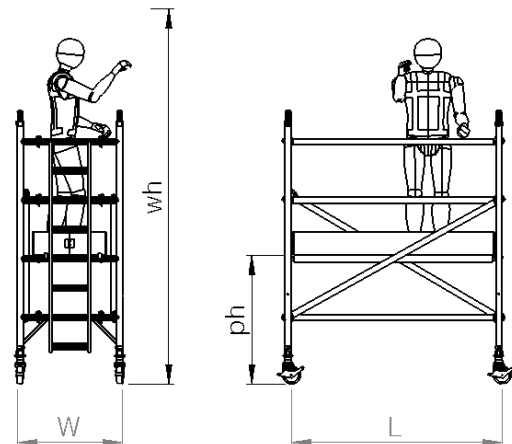

Technical information:

Base Dimensions:	(L)2.5m X (W)0.85m
Maximum Platform Height (ph):	10.2m
Maximum Working Height (wh):	12.2m
Maximum Working Load Per Platform:	275kg
Maximum Working Load Per Tower: (including tower weight)	950kg
Weight:	406.5kg

Example picture of a 1450 1.8m 2.2m Platform Height GRP Tower

01227 860085
Mon-Fri, 8am until 5pm

For More Information:
info@towersandpodiums.co.uk
We reply within 1 hour
Mon-Fri, 8am until 5pm



UTS SALES AND REPAIRS

A SAFER WAY TO REACH NEW HEIGHTS

Single Width Tower
2.5m Long x 0.85m Wide

Working Height
12.7m

Platform Height
10.7m

Tower Components

Item	Description	Quantity
1	Locking Caster	4
2	Adjustable Leg	4
3	2 Rung Ladder Frame	0
4	2 Rung Span Frame	0
5	3 Rung Ladder Frame	1
6	3 Rung Span Frame	1
7	4 Rung Ladder Frame	5
8	4 Rung Span Frame	5
9	2.5m Trapdoor Platform	5
10	2.5m Fixed Platform	0
11	2.5m Horizontal Brace	22
12	2.7m Diagonal Brace	20
13	Small Stabiliser	0
14	Large Stabiliser	4
15	Folding Toeboard	1

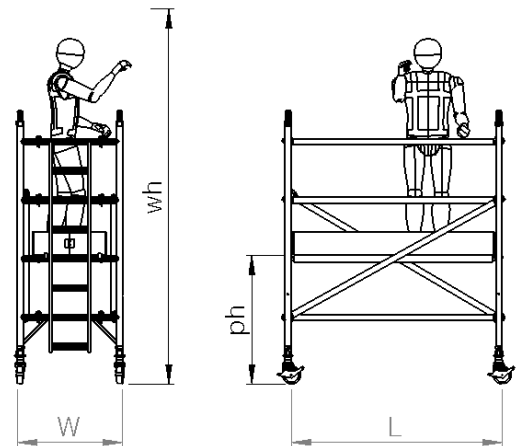

Technical information:

Base Dimensions:	(L)2.5m X (W)0.85m
Maximum Platform Height (ph):	10.7m
Maximum Working Height (wh):	12.7m
Maximum Working Load Per Platform:	275kg
Maximum Working Load Per Tower: (including tower weight)	950kg
Weight:	413.5kg

Example picture of a 1450 1.8m 2.2m Platform Height GRP Tower

01227 860085
Mon-Fri, 8am until 5pm

For More Information:
info@towersandpodiums.co.uk
We reply within 1 hour
Mon-Fri, 8am until 5pm



UTS SALES AND REPAIRS

A SAFER WAY TO REACH NEW HEIGHTS

Single Width Tower
2.5m Long x 0.85m Wide

Working Height
13.2m

Platform Height
11.2m

Tower Components

Item	Description	Quantity
1	Locking Caster	4
2	Adjustable Leg	4
3	2 Rung Ladder Frame	0
4	2 Rung Span Frame	0
5	3 Rung Ladder Frame	0
6	3 Rung Span Frame	0
7	4 Rung Ladder Frame	6
8	4 Rung Span Frame	6
9	2.5m Trapdoor Platform	6
10	2.5m Fixed Platform	0
11	2.5m Horizontal Brace	26
12	2.7m Diagonal Brace	21
13	Small Stabiliser	0
14	Large Stabiliser	4
15	Folding Toeboard	1

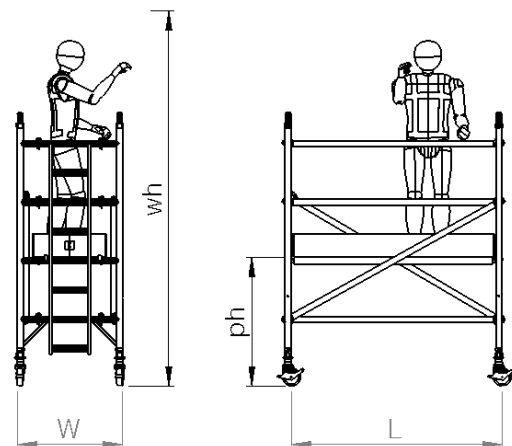

Technical information:

Base Dimensions:	(L)2.5m X (W)0.85m
Maximum Platform Height (ph):	11.2m
Maximum Working Height (wh):	13.2m
Maximum Working Load Per Platform:	275kg
Maximum Working Load Per Tower: (including tower weight)	950kg
Weight:	457.7kg

Example picture of a 1450 1.8m 2.2m Platform Height GRP Tower

01227 860085
Mon-Fri, 8am until 5pm

For More Information:
info@towersandpodiums.co.uk
We reply within 1 hour
Mon-Fri, 8am until 5pm



UTS SALES AND REPAIRS

A SAFER WAY TO REACH NEW HEIGHTS

Single Width Tower
2.5m Long x 0.85m Wide

Working Height
13.7m

Platform Height
11.7m

Tower Components

Item	Description	Quantity
1	Locking Caster	4
2	Adjustable Leg	4
3	2 Rung Ladder Frame	1
4	2 Rung Span Frame	1
5	3 Rung Ladder Frame	1
6	3 Rung Span Frame	1
7	4 Rung Ladder Frame	5
8	4 Rung Span Frame	5
9	2.5m Trapdoor Platform	6
10	2.5m Fixed Platform	0
11	2.5m Horizontal Brace	26
12	2.7m Diagonal Brace	22
13	Small Stabiliser	0
14	Large Stabiliser	4
15	Folding Toeboard	1

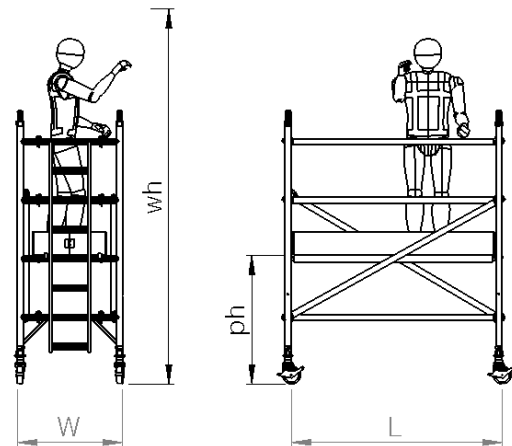

Technical information:

Base Dimensions:	(L)2.5m X (W)0.85m
Maximum Platform Height (ph):	11.7m
Maximum Working Height (wh):	13.7m
Maximum Working Load Per Platform:	275kg
Maximum Working Load Per Tower: (including tower weight)	950kg
Weight:	466.4kg

Example picture of a 1450 1.8m 2.2m Platform Height GRP Tower

01227 860085
Mon-Fri, 8am until 5pm

For More Information:
info@towersandpodiums.co.uk
We reply within 1 hour
Mon-Fri, 8am until 5pm



UTS SALES AND REPAIRS

A SAFER WAY TO REACH NEW HEIGHTS

Single Width Tower
2.5m Long x 0.85m Wide

Working Height
14.2m

Platform Height
12.2m

Tower Components

Item	Description	Quantity
1	Locking Caster	4
2	Adjustable Leg	4
3	2 Rung Ladder Frame	1
4	2 Rung Span Frame	1
5	3 Rung Ladder Frame	0
6	3 Rung Span Frame	0
7	4 Rung Ladder Frame	6
8	4 Rung Span Frame	6
9	2.5m Trapdoor Platform	6
10	2.5m Fixed Platform	0
11	2.5m Horizontal Brace	26
12	2.7m Diagonal Brace	23
13	Small Stabiliser	0
14	Large Stabiliser	4
15	Folding Toeboard	1

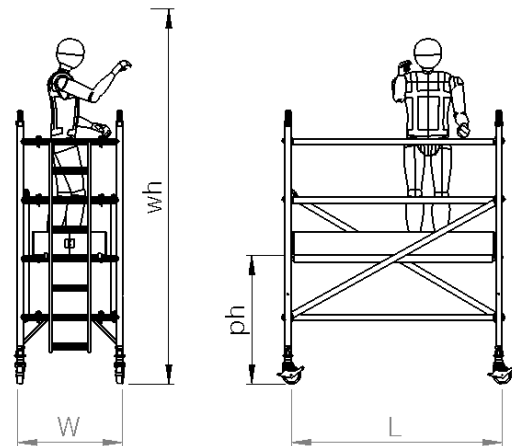

Technical information:

Base Dimensions:	(L)2.5m X (W)0.85m
Maximum Platform Height (ph):	12.2m
Maximum Working Height (wh):	14.2m
Maximum Working Load Per Platform:	275kg
Maximum Working Load Per Tower: (including tower weight)	950kg
Weight:	474.7kg

Example picture of a 1450 1.8m 2.2m Platform Height GRP Tower

01227 860085
Mon-Fri, 8am until 5pm

For More Information:
info@towersandpodiums.co.uk
We reply within 1 hour
Mon-Fri, 8am until 5pm

